

The BWA series are converter adapters used for connecting connectors of different series.

- (1) Has mating portions compatible in materials and finish with the respective series.
- (2) Conforms in performance to the lower series of the two connectors to be connected.

## Converter adapter list

Mating portion 1		Mating portion 2		Part No.	CL No.	Remarks	Shape
Series name	Mating portion	Series name	Mating portion				
N	P	BNC	P	NP-BNCP	311-0050-7		Fig.1
			J	JUG-201A/U	311-0007-8		Fig.2
		M	J	NP-MJ	311-0019-7		Fig.3
			J	N.P-S.J	311-0245-6		Fig.4
		HRM	P	HRM-555S	311-0125-4		Fig.5
			J	HRM-554S	311-0123-9		Fig.6
	J	BNC	P	UG-349/U	311-0004-0		Fig.7
				J	NJ-BNCJ	311-0005-2	
			J	NJ-BNCJ-PA	311-0014-3	Panel-mount type	Fig.9
		M	P	NJ-MP	311-0018-4		Fig.10
			J	NJ-MJ	311-0011-5		Fig.11
		TNC	P	N.J-TNC.P	311-0225-9		Fig.12
		HRM	P	HRM-553S	311-0121-3		Fig.13
				HRM-557S	311-0138-6	Panel-mount type	Fig.14
			J	HRM-552S	311-0119-1		Fig.15
				HRM-556S	311-0127-0	Panel-mount type	Fig.16
BNC	P	M	P	BNCP-MP	311-0062-6		Fig.17
			J	BNCP-MJ	311-0008-0		Fig.18
		S	P	SP-BNCP	311-0055-0		Fig.19
			J	SJ-BNCP	311-0060-0		Fig.20
		UM	J	BNCP-UMJ	311-0065-4		Fig.21
		MSS	P	BNCP-MSSP	311-0107-2		Fig.22
			J	BNCP-MSSJ	311-0082-3		Fig.23
		HRM	P	HRM-519(09)	311-0101-6-09		Fig.24
	J		HRM-518(09)	311-0100-3-09		Fig.25	
	J	UHF	P	UG-273/U	311-0003-7		Fig.26
		M	P	BNCJ-MP	311-0009-3		Fig.27
			J	MJ-BNCJ	311-0020-6		Fig.28
		S	P	SP-BNCJ	311-0058-9		Fig.29
				J	SJ-BNCJ	311-0054-8	
			J	SJ-BNCJ-PA	311-0108-5	Panel-mount type	Fig.31
		TNC	J	BNC.J-TNC.J	311-0194-7		Fig.32
		UM	P	BNCJ-UMP	311-0052-2		Fig.33
J			BNCJ-UMJ	311-0053-5		Fig.34	
	J	BNCJ-UMJ-PA(04)	311-0103-1-04	Panel-mount type	Fig.35		
MSS	P	BNCJ-MSSP	311-0081-0		Fig.36		
	J	BNCJ-MSSJ	311-0066-7		Fig.37		

# BWA SERIES RF CO-AXIAL CONNECTORS

Mating portion 1		Mating portion 2		Part No.	CL No.	Remarks	Shape	
Series name	Mating portion	Series name	Mating portion					
BNC	J	HRM	P	HRM-517(09)	311-0099-6-09		Fig.38	
			J	HRM-516(09)	311-0102-9-09		Fig.39	
		POD	P	BNCJ-PODP	311-0160-5		Fig.40	
			J	BNCJ-PODJ	311-0161-8		Fig.41	
		PO6	J	BNCJ-PO6J	311-0167-4		Fig.42	
S	P	HRM	P	HRM-509(09)	311-0093-0-09		Fig.43	
			J	HRM-508(09)	311-0092-7-09		Fig.44	
	J	HRM	P	HRM-507(09)	311-0091-4-09		Fig.45	
				HRM-512(09)	311-0098-3-09	Panel-mount type	Fig.46	
			HRM-512S	311-0144-9	Panel-mount type, S type	Fig.46		
			HRM-506(09)	311-0090-1-09		Fig.47		
			J	HRM-511(09)	311-0094-2-09	Panel-mount type	Fig.48	
			HRM-511S	311-0143-6	Panel-mount type, S type	Fig.48		
TNC	J	HRM	J	HRMJ-TNCJ-PA	311-0202-3	Panel-mount type	Fig.49	
UM	P	HRM	J	UM.P-HRM.J	311-0176-5		Fig.50	
	J	HRM	J	HRMJ-UMJ	311-0164-6		Fig.51	
HRM	P	POB	P	HRMP-POBP-1	311-0169-0		Fig.52	
			J	HRMP-POBJ	311-0152-7		Fig.53	
		POD	J	HRM.P-POD.J	311-0177-8		Fig.54	
		POD1	J	HRMP-POD1J	311-0253-4		Fig.55	
		PO6	J	HRMP-PO6J	311-0172-4		Fig.56	
		S.FLSFL2	J	HRMP-S.FLJ-2	311-0249-7	For inspecting harnessed parts	Fig.57	
		H.FL	J	HRMP-H.FLJ	311-0232-4	For inspecting harnessed parts	Fig.58	
		HRMM	P	HRMP-HRMMP	311-0250-6		Fig.59	
			J	HRMP-HRMMJ	311-0243-0		Fig.60	
				J	HRMP-HRMMJ-LA	311-0226-1		Fig.61
		J	POB	P	HRMJ-POBP	311-0151-4		Fig.62
	HRMJ-POBP-PA				311-0206-4		Fig.63	
	J			HRMJ-POBJ	311-0149-2		Fig.64	
				HRMJ-POBJ-PA	311-0150-1		Fig.65	
	POD		P	HRMJ-PODP	311-0157-0		Fig.66	
	POD1		P	HRMJ-POD1P-1	311-0254-7		Fig.67	
	PO6		P	HRMJ-PO6P	311-0173-7		Fig.68	
	PO51		P	HRMJ-PO51P	311-0231-1		Fig.69	
	FL		P	HRMJ-FLP-1	311-0195-0		Fig.70	
			J	HRMJ-FLJ	311-0179-3		Fig.71	
	S.FLSFL2		P	HRMJ-S.FLP	311-0218-3		Fig.72	
	H.FL		P	HRMJ-H.FLP-3	311-0264-0		Fig.73	
	HRMM	P	HRMJ-HRMMP-2	311-0221-8		Fig.74		
HRMJ-HRMMP-LA			311-0227-4		Fig.75			
J		HRMJ-HRMMJ	311-0220-5		Fig.76			

Note 1. Part No. NP-BNCP of Fig.1 is shown that series name N, coupling part p (plug) for connecting part 1 and series name BNC, coupling part P (plug) for connecting part 2.

2. Series name of each connecting parts are shown in order to HIROSE's CL numbers.

Fig.1

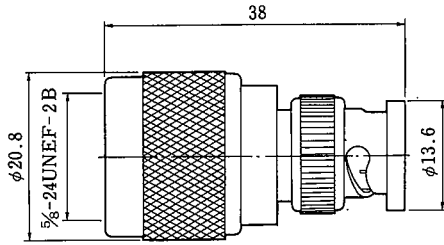

NP-BNCP  
CL311-0050-7

Fig.2

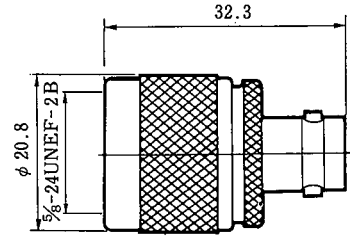

UG-201A/U  
CL311-0007-8

Fig.3

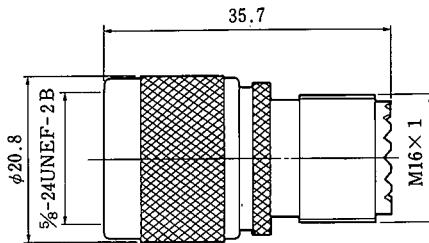

NP-MJ  
CL311-0019-7

Fig.4

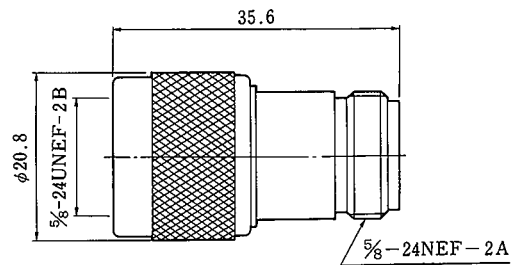

N.P-S.J  
CL311-0245-6

Fig.5

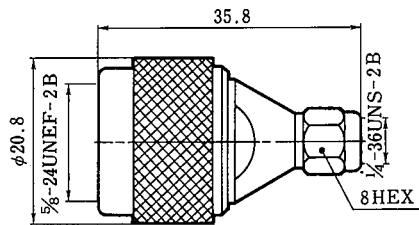

HRM-555S  
CL311-0125-4

Fig.6

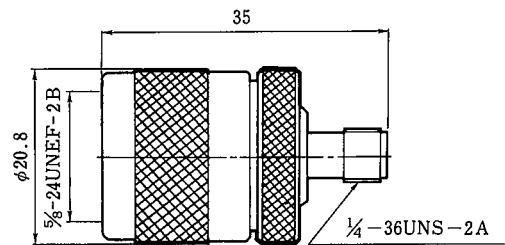

HRM-554S  
CL311-0123-9

Fig.7

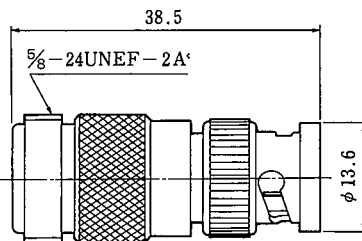

UG-349/U  
CL311-0004-0

Fig.8

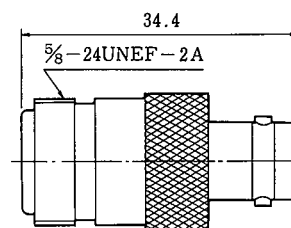

NJ-BNCJ  
CL311-0005-2

Fig.9

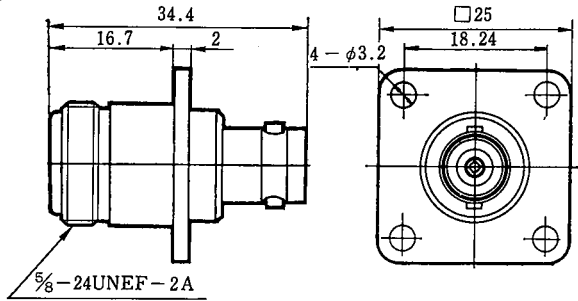

NJ-BNCJ-PA  
CL311-0014-3

Fig.10

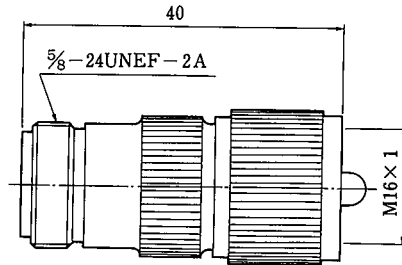

NJ-MP  
CL311-0018-4

Fig.11

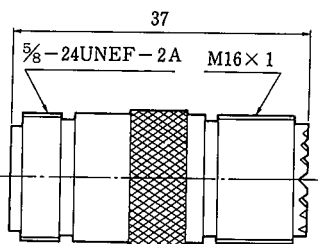

NJ-MJ  
CL311-0011-5

Fig.12

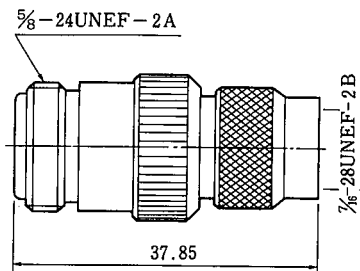

N.J-TNC.P  
CL311-0225-9

Fig.13

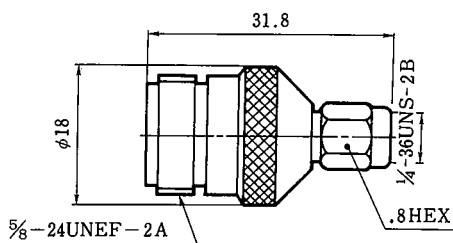

HRM-553S  
CL311-0121-3

Fig.14

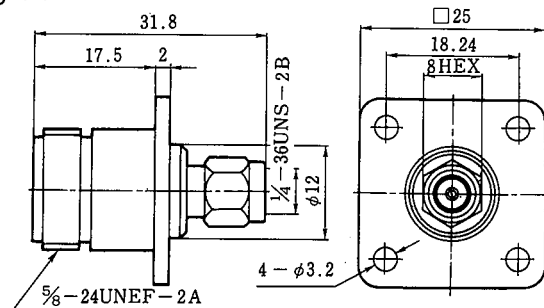

HRM-557S  
CL311-0138-6

Fig.15

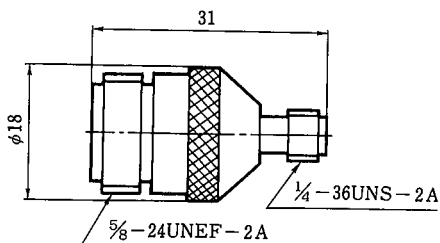

HRM-552S  
CL311-0119-1

Fig.16

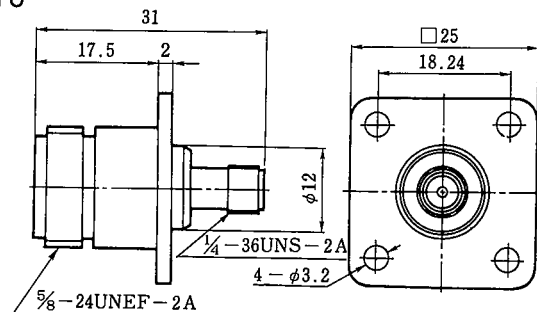

HRM-556S  
CL311-0127-0

Fig.17

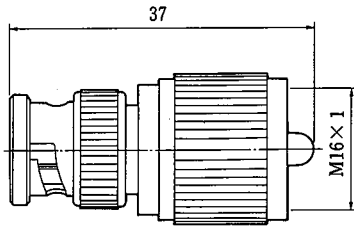

BNCP-MP  
CL311-0062-6

Fig.18

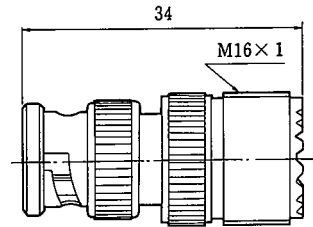

BNCP-MJ  
CL311-0008-0

Fig.19

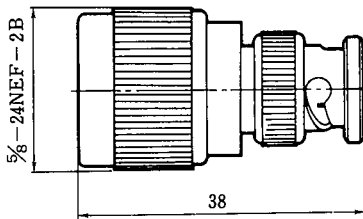

SP-BNCP  
CL311-0055-0

Fig.20

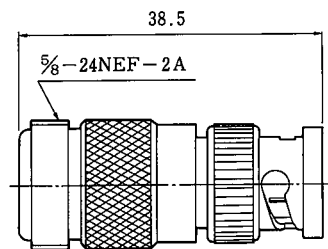

SJ-BNCP  
CL311-0060-0

Fig.21

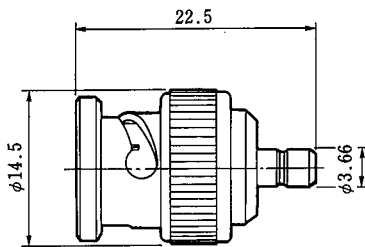

BNCP-UMJ  
CL311-0065-4

Fig.22

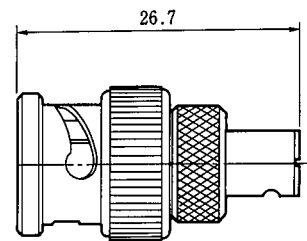

BNCP-MSSP  
CL311-0107-2

Fig.23

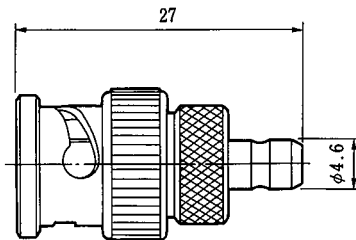

BNCP-MSSJ  
CL311-0082-3

Fig.24

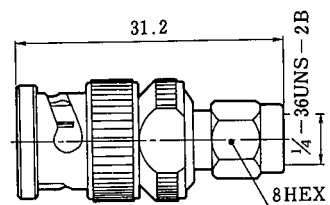

HRM-519(09)  
CL311-0101-6-09

# BWA SERIES RF CO-AXIAL CONNECTORS

Fig.25

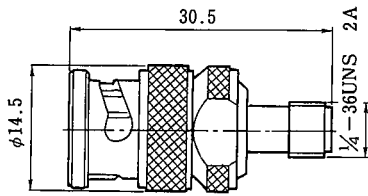

HRM-518(09)  
CL311-0100-3-09

Fig.26

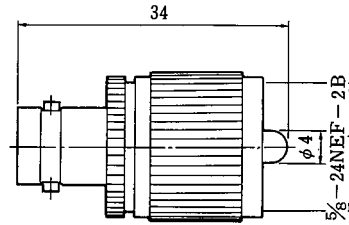

UG-273/U  
CL311-0003-7

Fig.27

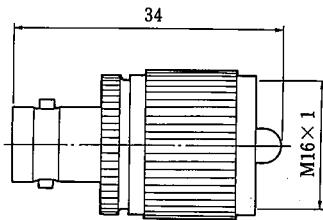

BNCJ-MP  
CL311-0009-3

Fig.28

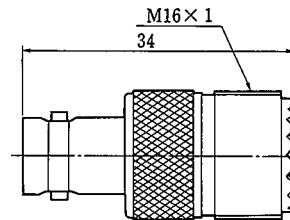

MJ-BNCJ  
CL311-0020-6

Fig.29

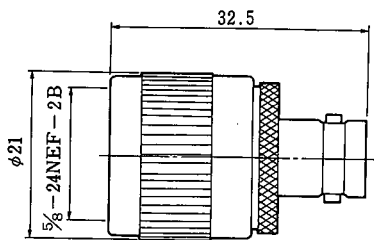

SP-BNCJ  
CL311-0058-9

Fig.30

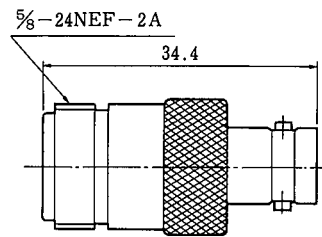

SJ-BNCJ  
CL311-0054-8

Fig.31

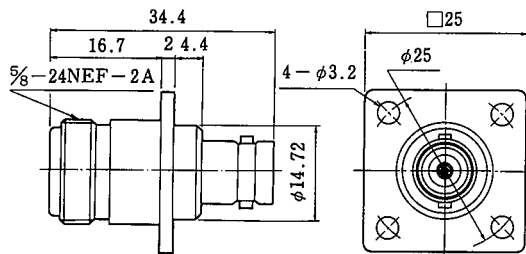

SJ-BNCJ-PA  
CL311-0108-5

Fig.32

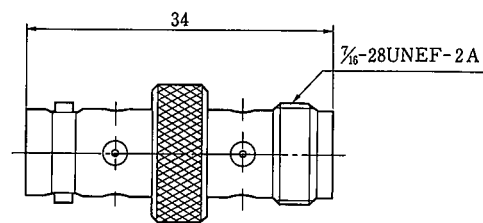

BNC.J-TNC.J  
CL311-0194-7

Fig.33

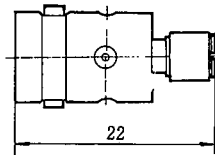

BNCJ-UMP  
CL311-0052-2

Fig.34

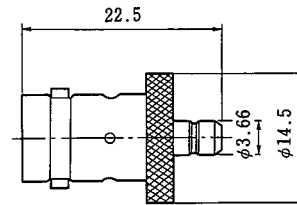

BNCJ-UMJ  
CL311-0053-5

Fig.35

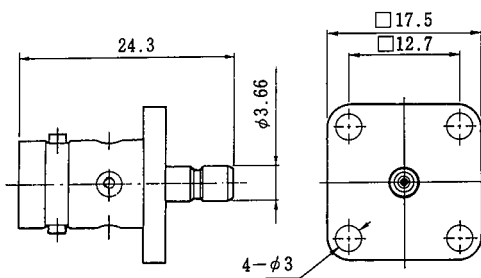

BNCJ-UMJ-PA (04)  
CL311-0103-1-04

Fig.36

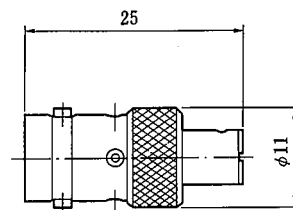

BNCJ-MSSP  
CL311-0081-0

Fig.37

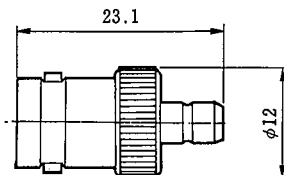

BNCJ-MSSJ  
CL311-0066-7

Fig.38

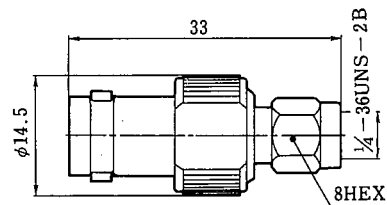

HRM-517 (09)  
CL311-0099-6-09

Fig.39

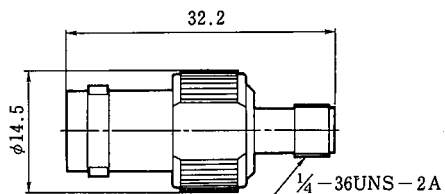

HRM-516 (09)  
CL311-0102-9-09

Fig.40

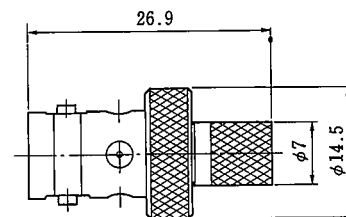

BNCJ-PODP  
CL311-0160-5

Fig.41

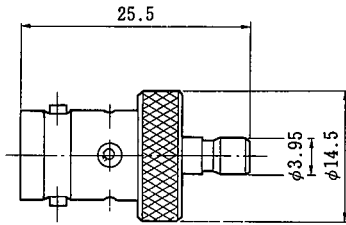

BNCJ-PODJ  
CL311-0161-8

Fig.42

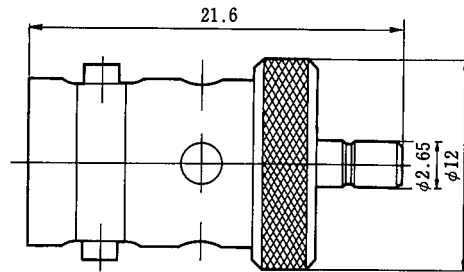

BNCJ-PO6J  
CL311-0167-4

Fig.43

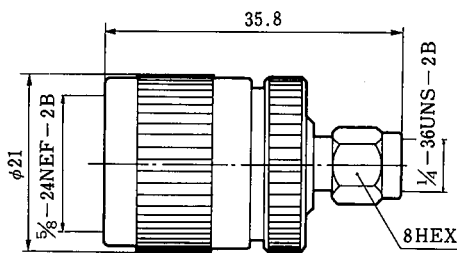

HRM-509 (09)  
CL311-0093-0-09

Fig.44

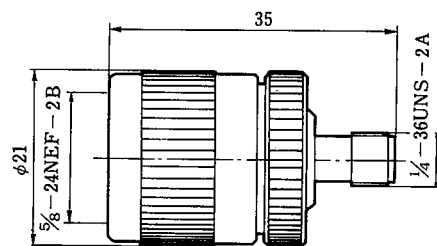

HRM-508 (09)  
CL311-0092-7-09

Fig.45

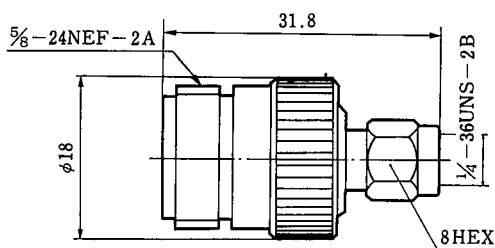

HRM-507 (09)  
CL311-0091-4-09

Fig.46

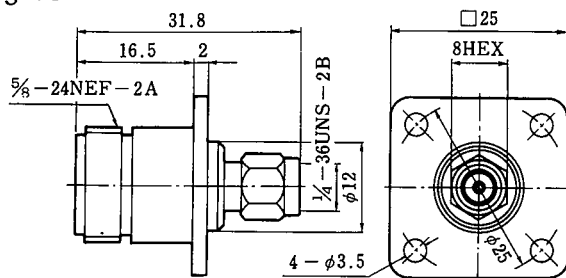

HRM-512 (09)  
CL311-0098-3-09

HRM-512S  
CL311-0144-9

Fig.47

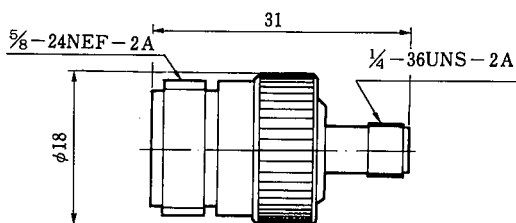

HRM-506 (09)  
CL311-0090-1-09

Fig.48

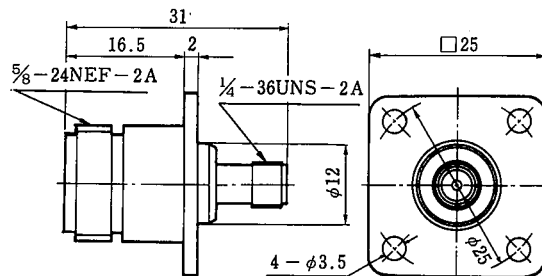

HRM-511 (09)  
CL311-0094-2-09

HRM-511S  
CL311-0143-6



<p>Fig.49</p> <p>HRMJ-TNCJ-PA CL311-0202-3</p>	<p>Fig.50</p> <p>UM.P-HRM.J CL311-0176-5</p>
<p>Fig.51</p> <p>HRMJ-UMJ CL311-0164-6</p>	<p>Fig.52</p> <p>HRMP-POBP-1 CL311-0169-0</p>
<p>Fig.53</p> <p>HRMP-POBJ CL311-0152-7</p>	<p>Fig.54</p> <p>HRM.P-POD.J CL311-0177-8</p>
<p>Fig.55</p> <p>HRMP-POD1J CL311-0253-4</p>	<p>Fig.56</p> <p>HRMP-PO6J CL311-0172-4</p>

# BWA SERIES RF CO-AXIAL CONNECTORS

Fig.57

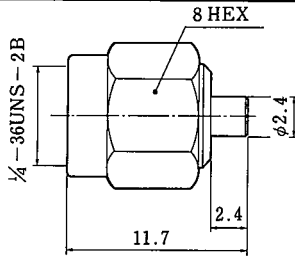

Note : The mating portion on the S. FL side mates with the S. FL and S. FL2 plugs. Having no locking mechanism, however, the S. FL side mating portion can be used only for performance measurement.

HRMP-S.FLJ-2  
CL311-0249-7

Fig.58

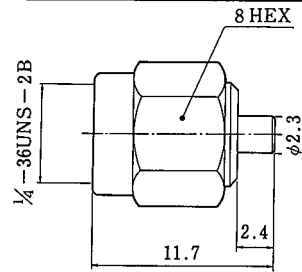

Note : Having no locking mechanism, however, the S. FL side mating portion can be used only for performance measurement.

HRMP-H.FLJ  
CL311-0232-4

Fig.59

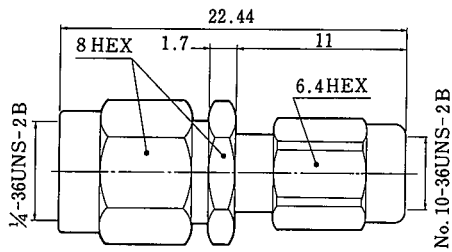

HRMP-HRMMP  
CL311-0250-6

Fig.60

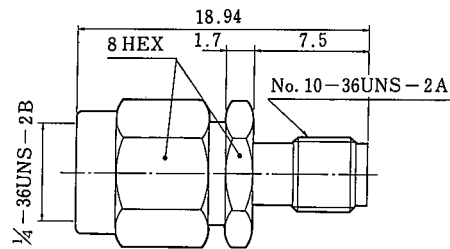

HRMP-HRMMJ  
CL311-0243-0

Fig.61

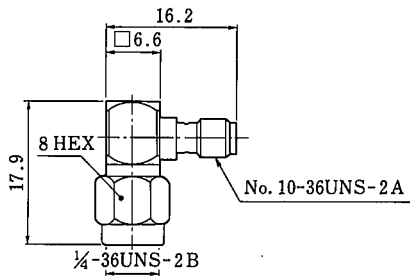

HRMP-HRMMJ-LA  
CL311-0226-1

Fig.62

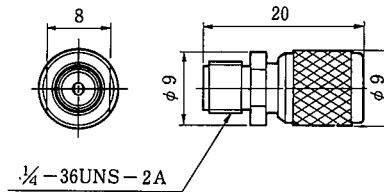

HRMJ-POBP  
CL311-0151-4

Fig.63

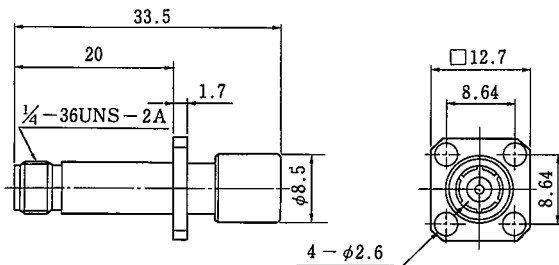

HRMJ-POBP-PA  
CL311-0206-4

Fig.64

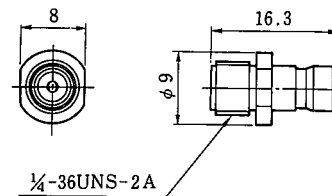

HRMJ-POBJ  
CL311-0149-2

Fig.65

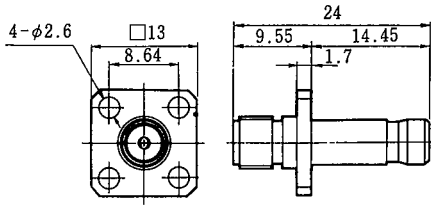

HRMJ-POBJ-PA  
CL311-0150-1

Fig.66

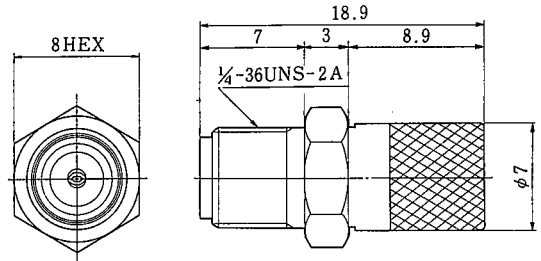

HRMJ-PODP  
CL311-0157-0

Fig.67

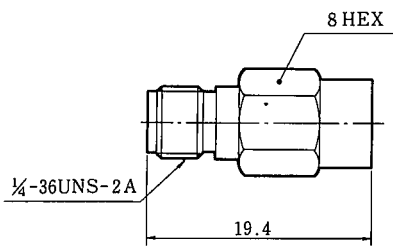

HRMJ-POD1P-1  
CL311-0254-7

Fig.68

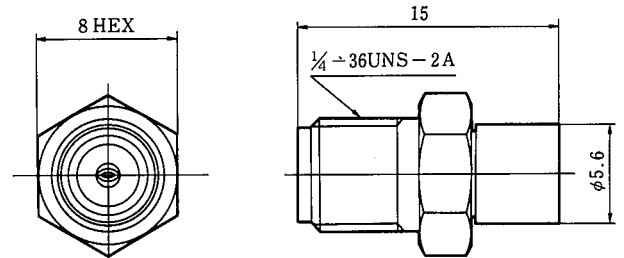

HRMJ-PO6P  
CL311-0173-7

Fig.69

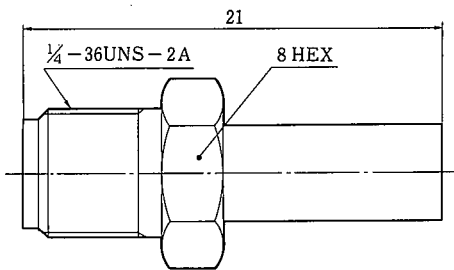

HRMJ-PO51P  
CL311-0231-1

Fig.70

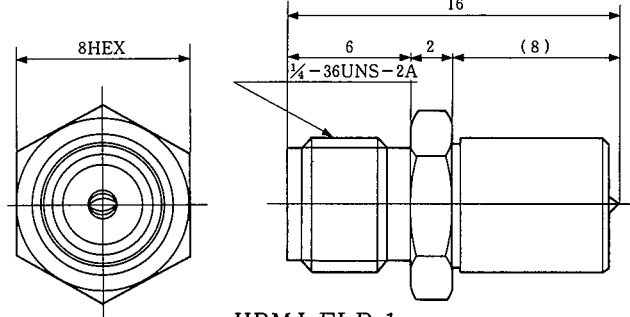

HRMJ-FLP-1  
CL311-0195-0

Fig.71

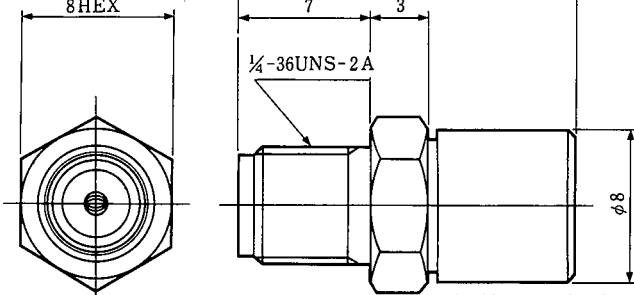

HRMJ-FLJ  
CL311-0179-3

Note: Having no locking mechanism, however, the FL side mating portion can be used only for performance measurement.

Fig.72

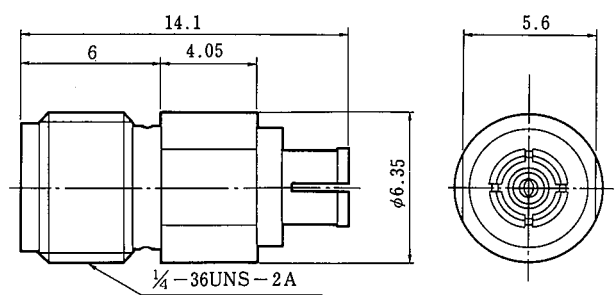

HRMJ-S.FLP  
CL311-0218-3

Note: Compatible with S. FL and S. FL2.

# BWA SERIES RF CO-AXIAL CONNECTORS

Fig.73

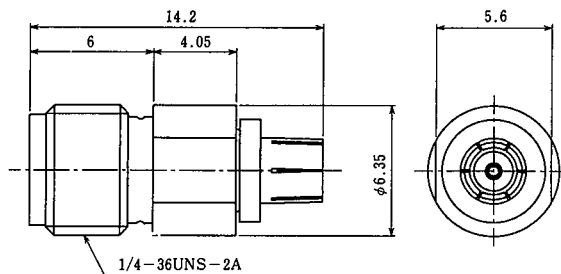

HRMJ-H.FLP-3  
CL311-0264-0

Fig.74

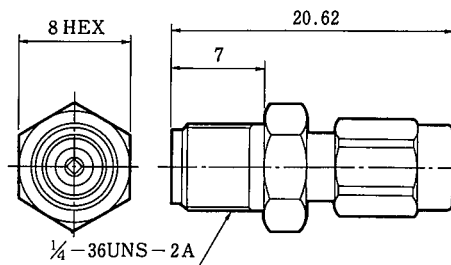

HRMJ-HRMMP-2  
CL311-0221-8

Fig.75

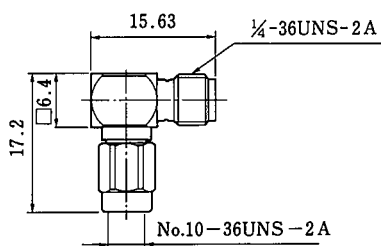

HRMJ-HRMMP-LA  
CL311-0227-4

Fig.76

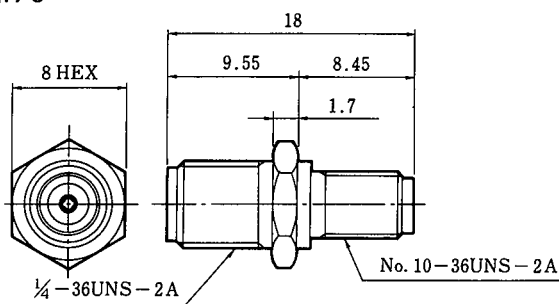

HRMJ-HRMMJ  
CL311-0220-5